

Meeting of Kilkenny County Council
Monday, 18th July 2022



Kilkenny Northern Ring Road Extension Strategic Assessment Report (SAR)

Dermot Donovan, Roadplan Consulting

Location and Layout of Previous Scheme

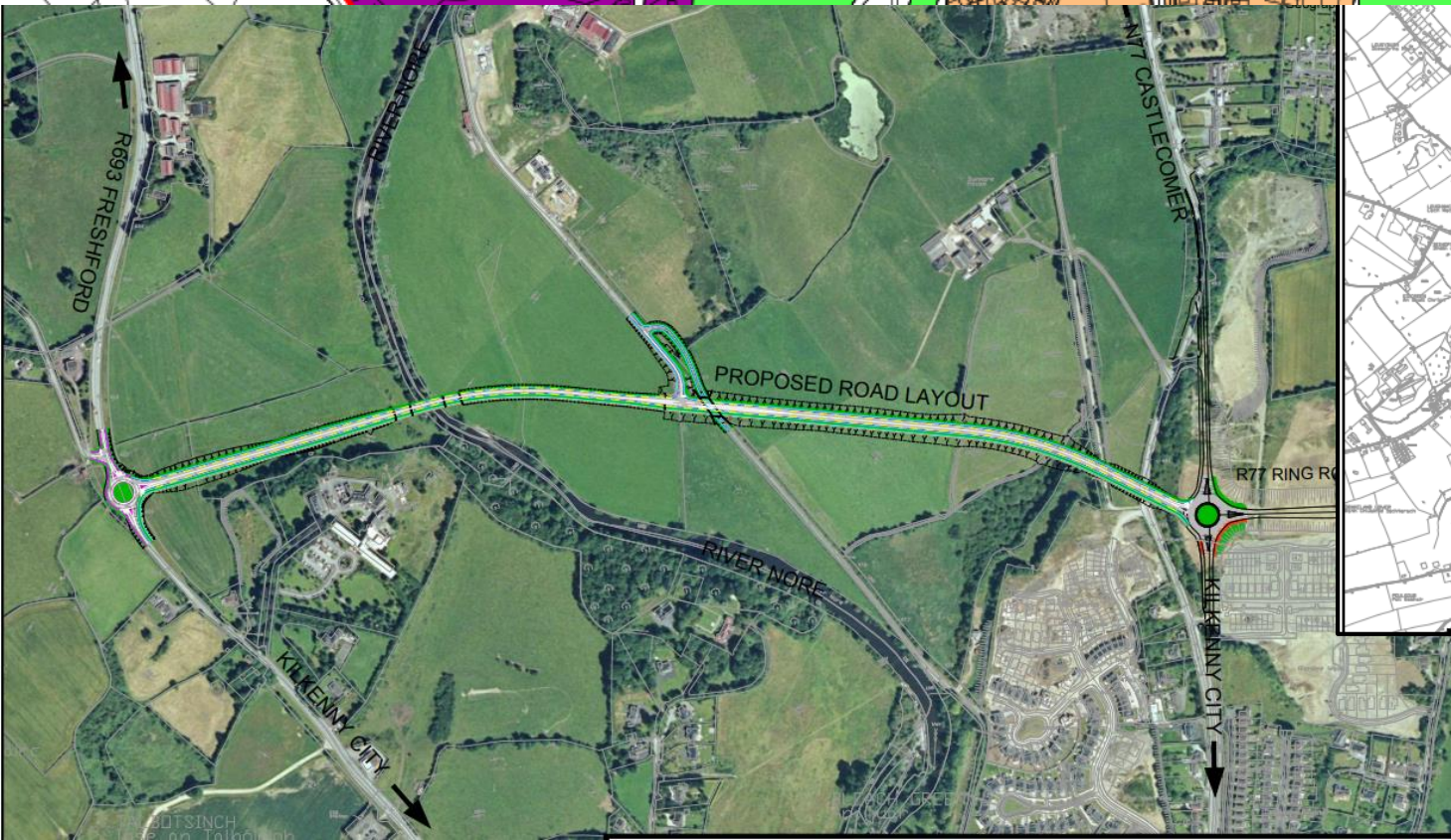
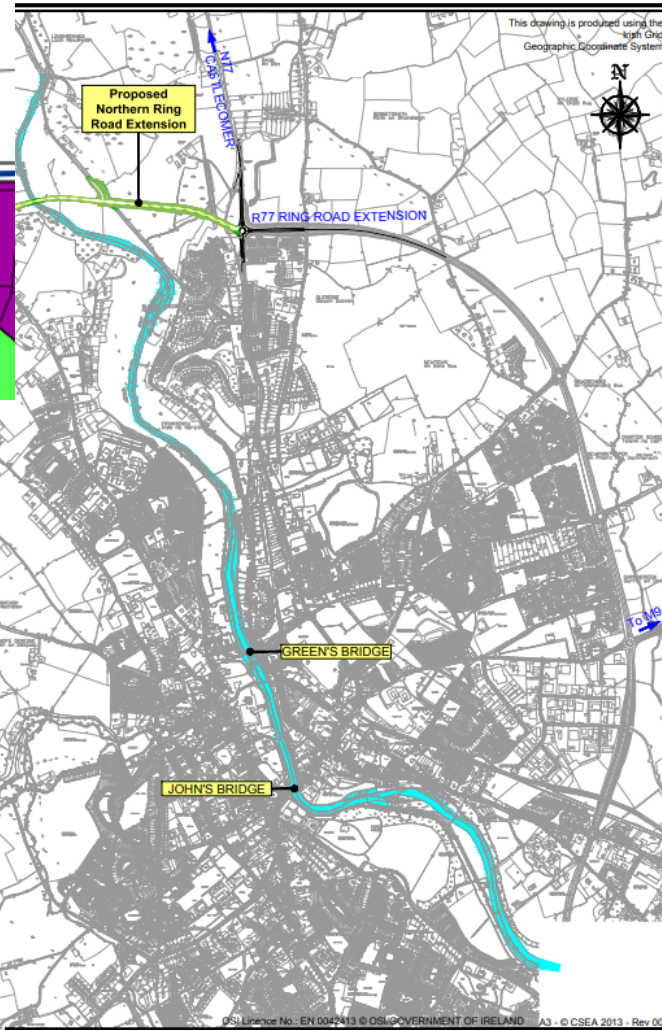
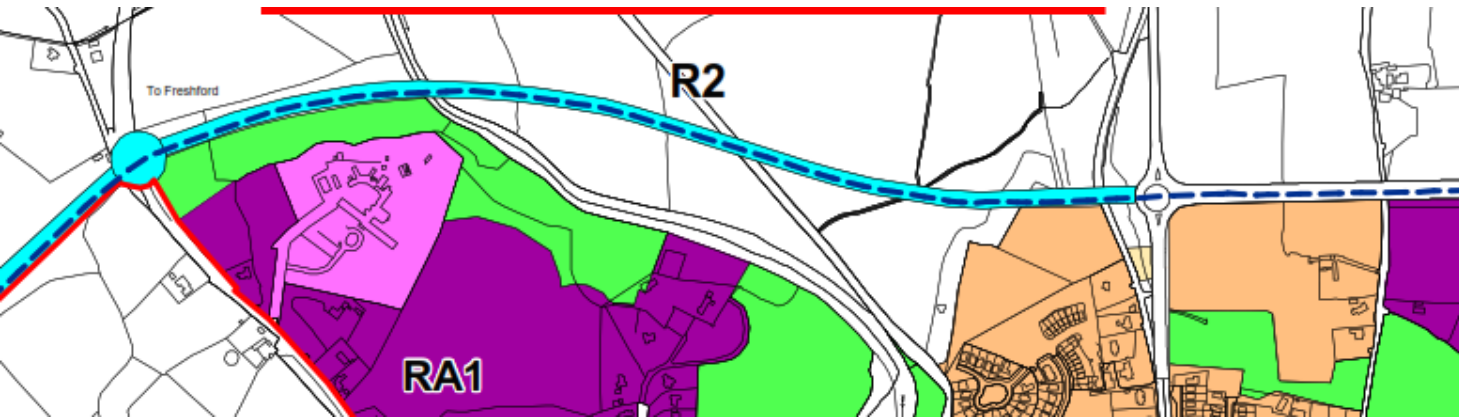

Bridge Elevation

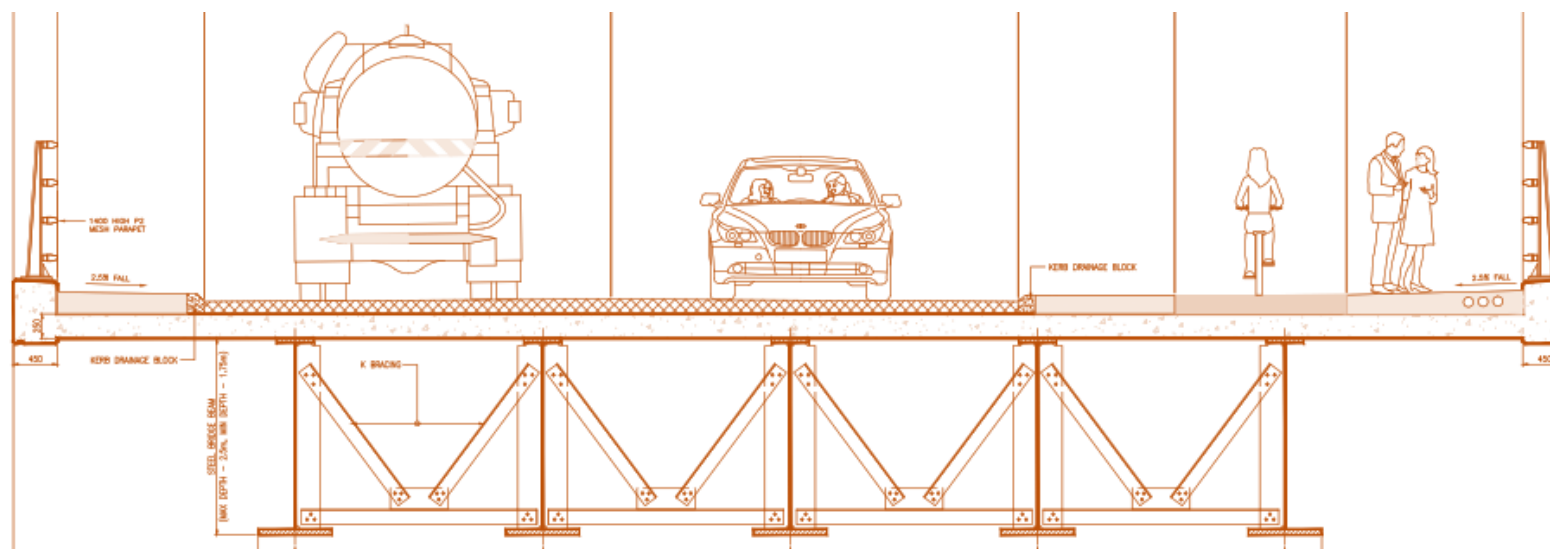
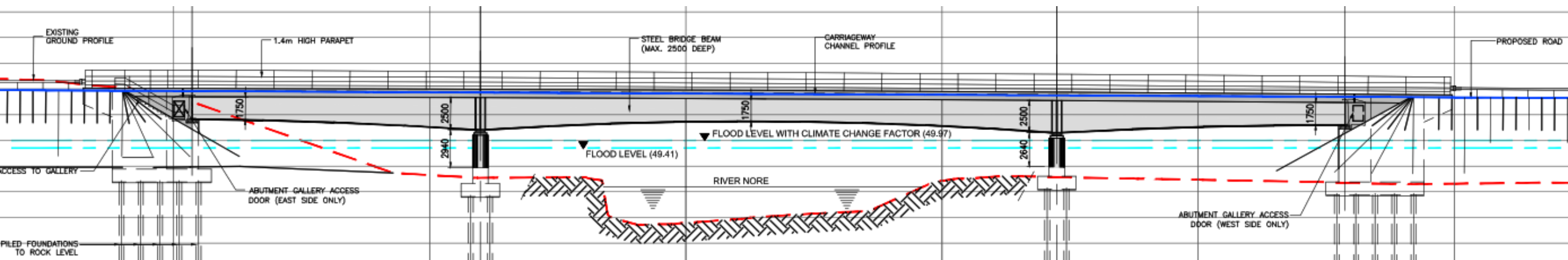







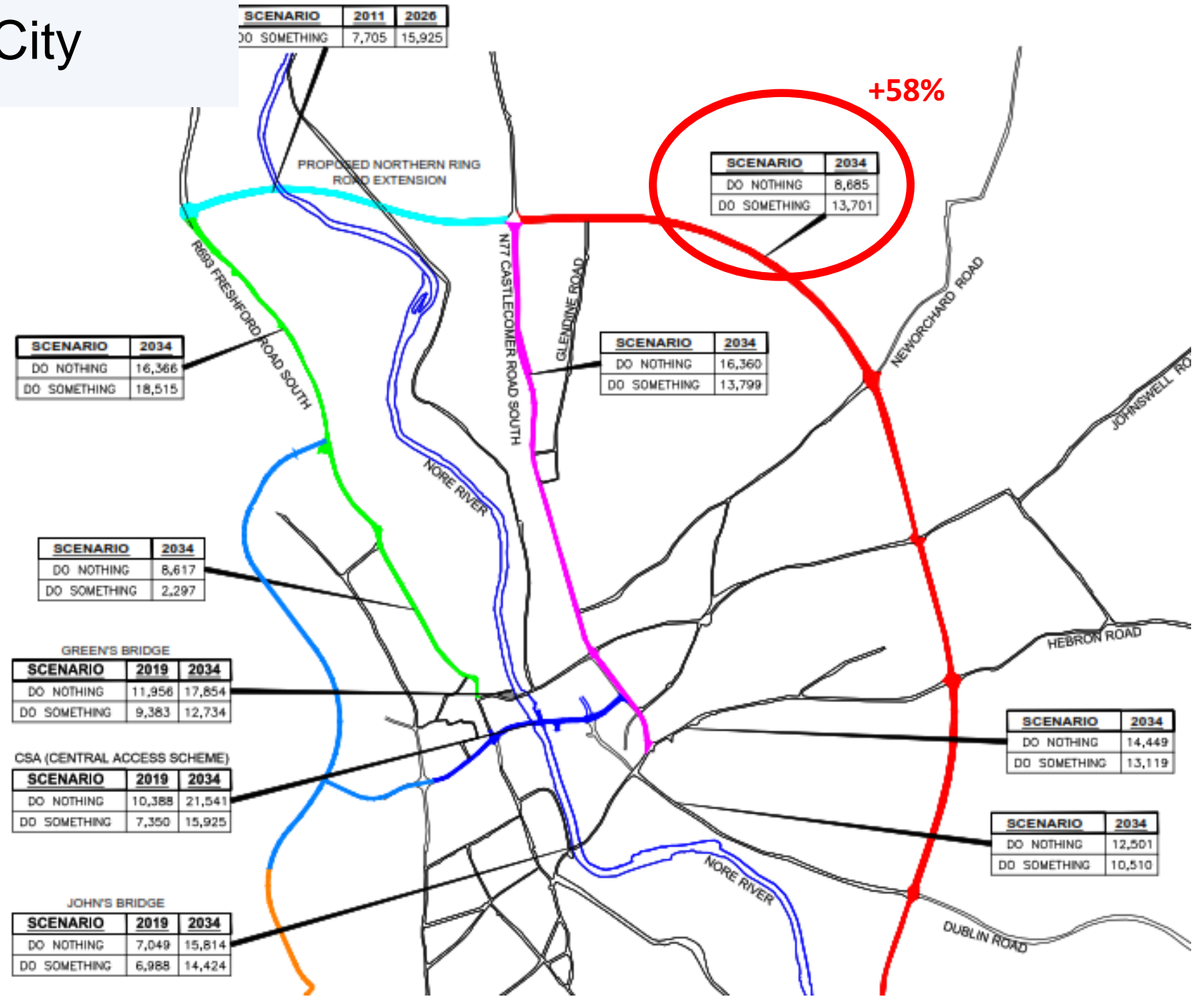





Bridge Cross-section

Traffic Reduction in the City

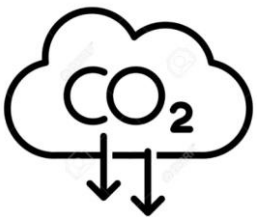
- 29% reduction on Green's bridge
- Reductions on
 - John's bridge
 - Castlecomer Road
 - Dublin Road
 - Etc
- Better use of N77 Ring Road – 58% increase.
- Minor increase on Freshford Road – north of hospital – until western bypass built



Objectives and Benefits of the Scheme

| | | | |
|--|---|--|---|
|  PEOPLE BRIDGE Link Neighbourhoods |  GDP Economic Growth |  Connect M8 to M9 |  HGV Prohibition |
|  Traffic Reduction |  Modal shift + Active travel |  Emissions Reduction |  Road safety |
|  Improved public realm |  Reduced noise pollution |  Air quality |  Planning and development (Loughmacask) |

Challenges

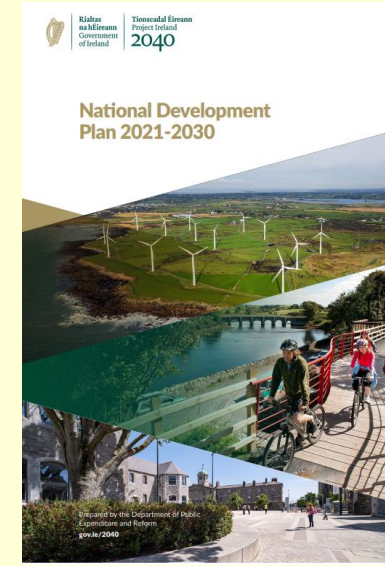
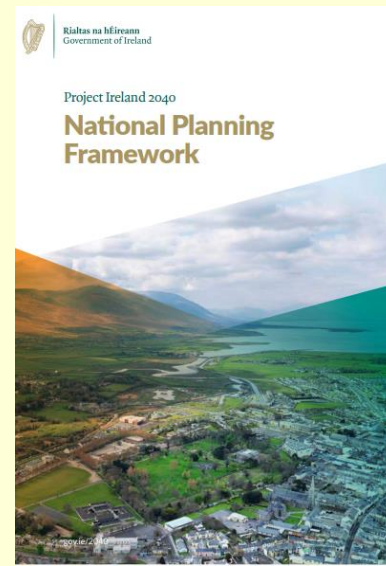

Policies and Plans



Induced traffic



Modal shift

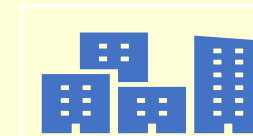

City centre uses

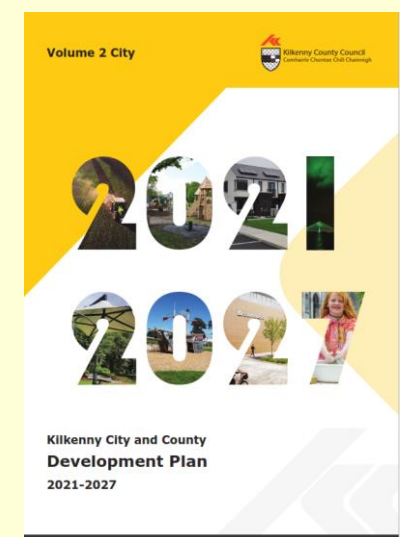
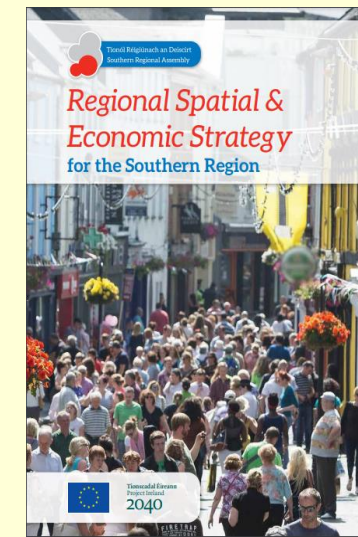
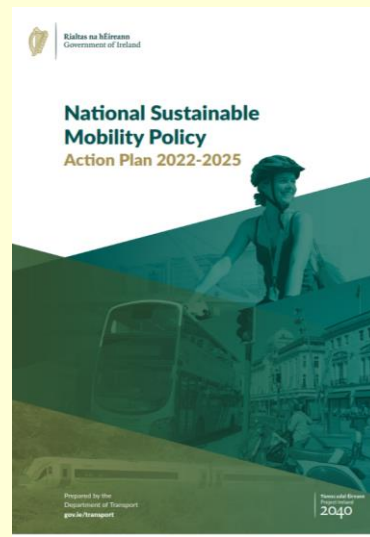
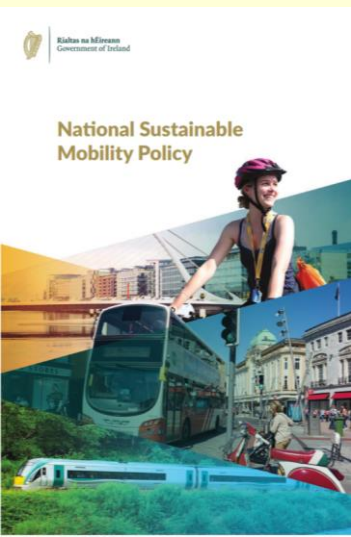

Long-List of Potential Options

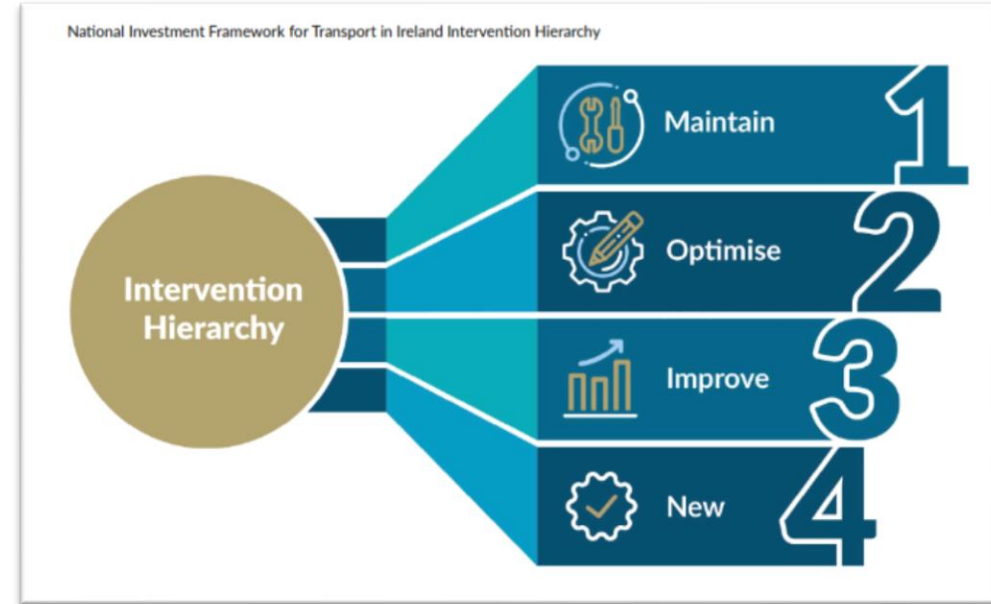
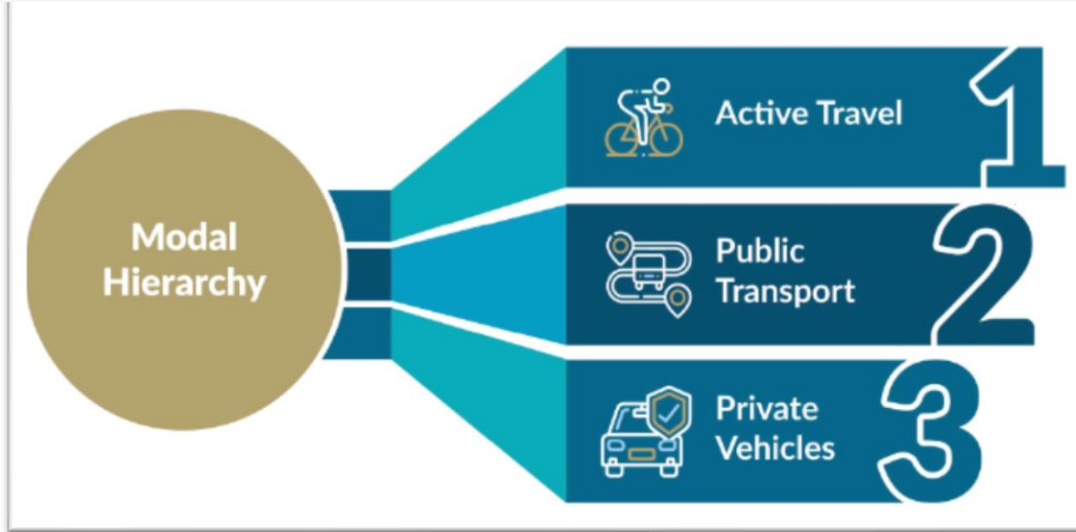

Recommended Hierarchy for Option Selection

The need is to take traffic and HGVs out of the city. New infrastructure is needed. It needs to cater for private vehicles, but it should cater for all three modes: it should be an All-Purpose scheme.

| | |
|-----------------|---|
| Option 1 | An All-purpose bridge |
| Option 2 | An All-purpose bridge and a separate active travel bridge |
| Option 3 | An All-purpose bridge with bus priority measures |
| Option 4 | Option 2 and 3 combined |

Long List of Options

Public Spending Code

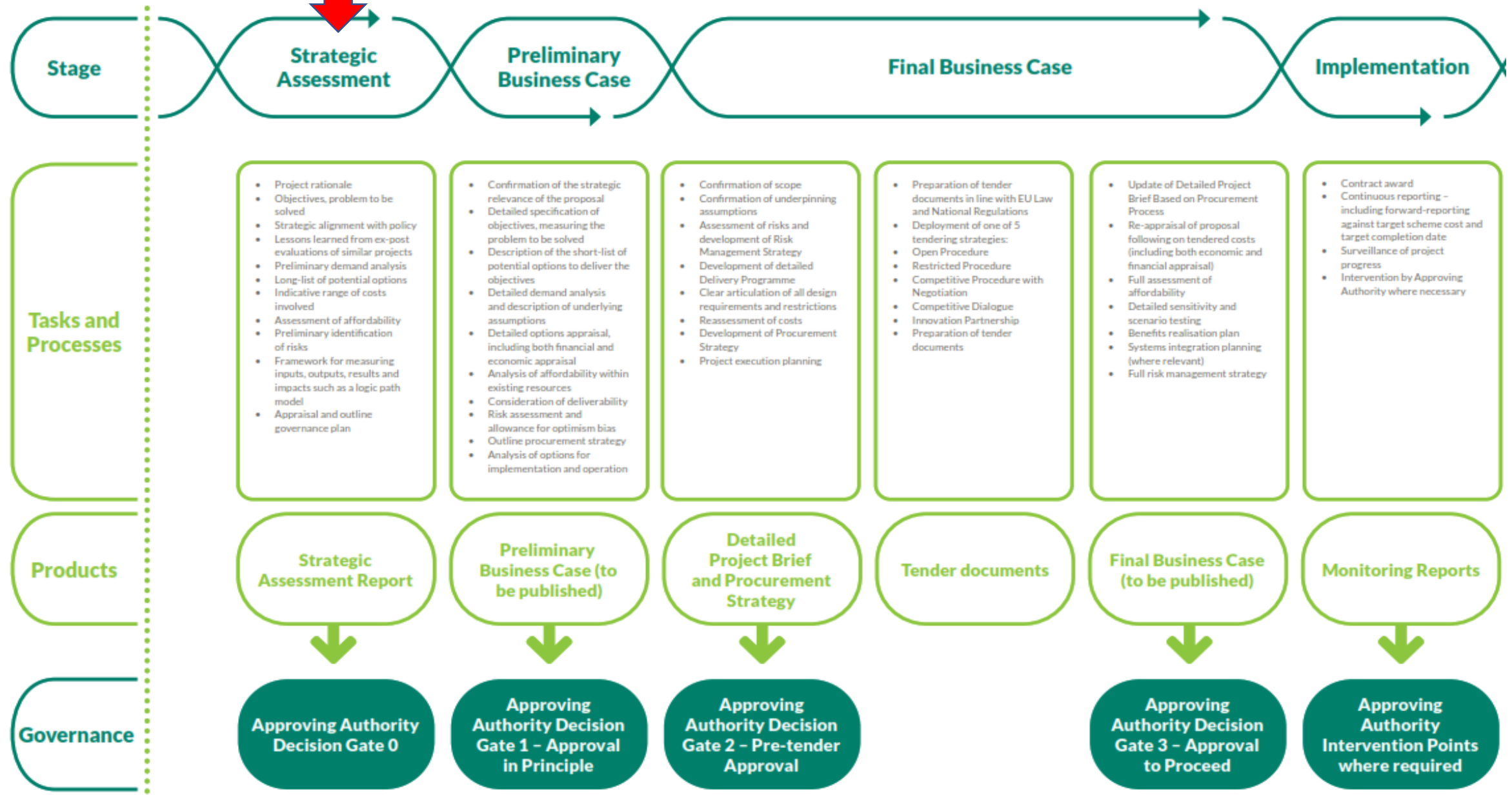

Meeting of Kilkenny County Council
Friday, 8th July 2022



Kilkenny Northern Ring Road Extension Strategic Assessment Report (SAR)